

VERSACHARGER

Caricatore wireless | Wireless charger

SCHEDA TECNICA | DATA SHEET

ED.07_19.09.2024

VERSACHARGER

Caricatore wireless | Wireless charger



DATI COMMERCIALI | COMMERCIAL DATA

Codice prodotto Product code	060.09	Codice famiglia di prodotto - Valido per tutte le configurazioni Family product code - Valid for all configurations
---------------------------------	--------	--

DATI TECNICI | TECHNICAL DATA

GENERALE | GENERAL

Standard wireless di ricarica Wireless charging standard	Qi
Connettore di alimentazione Power supply connectr	Micro USB B
Indicatore di ricarica Charging indicator	Lunimoso: LED blu Luminous: LED blue
Ambiente di utilizzo Operating environment	Interno, asciutto Indoor, dry

GENERALE | GENERAL

Temperatura di utilizzo Operating temperature	0°C - 40°C
Temperatura di stoccaggio Storage temperature	-20°C - 75°C
Umidità di servizio Operating humidity	25% - 85%
Umidità di stoccaggio Storage humidity	5% - 95%

MATERIALI | MATERIALS

Corpo Body	Tecnopolimero autoestinguente Flame retardant polymer
Disco di Finitura Finishing Disk	Disco Metacrilato Methacrylate Disk
Cornice Frame	Zama Zamak





POTENZA RICARICA INGRESSO | INPUT CHARGING POWER

Tensione Input voltage	5Vdc \pm 5% 9Vdc \pm 5%
Corrente Input current	2A
Assorbimento in standby Standby power Dissipation	<0.1W

POTENZA RICARICA USCITA | OUTPUT CHARGING POWER

Tensione Input voltage	5W (Qi BPP); 7.5W (Apple FAI); 10W Samsung protocol; 15W (Qi EPP)		
tolleranza Input current	\pm 5%		
Corrente Output Current	MAX load	1.1 A	QC2.0/QC3.0
	MIN load	0 A	QC2.0/QC3.0
Compatibilità Compatibility	Tutti gli smartphone dotati di sistema di ricarica wireless All smartphones equipped with a wireless charging system		

FINITURE | FINISHES

Corpo Body		Disco Disc	
	Acciaio spazzolato Stainless steel		Nero/Bianco Black/White
	Bianco Pure white		Bianco White
	Nero opaco Matt black		Nero Black
	Cromo lucido Polished chrome		Nero/Bianco Black/White



NOTE | NOTES

- Accessori: Cavo da spina USB tipo A a spina micro USB tipo B.

- Alimentatore AC/DC con uscita USB non incluso.
- Compatibile con qualsiasi dispositivo che supporti lo standard Qi.
- Disponibili a richiesta altre finiture.
- Uso solo in ambienti interni.

- Accessories: Cable with USB plug type A to micro USB plug type B.

- AC/DC power adapter with USB output not included.
- Compatible with any Qi rated device.
- Other finishes available upon request.
- Indoor use only.



RAEE - Rifiuti derivanti da Apparecchiature Elettriche ed Elettroniche. Questi prodotti devono essere riciclati in modo adeguato e non devono essere gettati fra i rifiuti domestici o nei rifiuti municipali indifferenziati.

WEEE - Waste of electric and electronic equipment. These products must be recycled properly and should not be disposed as household waste. Disposal in general household waste is prohibited.

Tutte le dimensioni indicate sono nominali. I disegni e le immagini sono solo a scopo illustrativo.
I dettagli del prodotto e le dimensioni sono soggetti a modifiche senza preavviso.

All dimensions quoted are nominal only. Drawings and images are for illustrative purposes only.
All product dimensions and specifications are subject to change without notice.

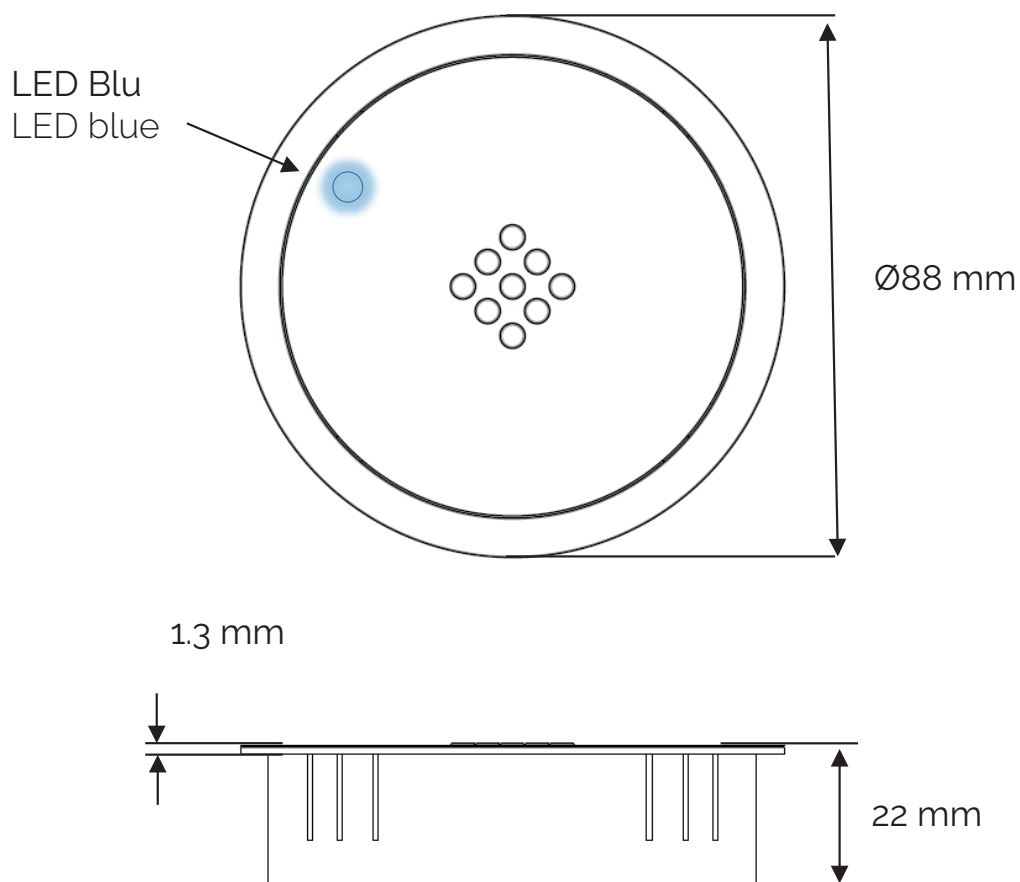

PIANO DI TAGLIO | CUT OUT DIMENSION

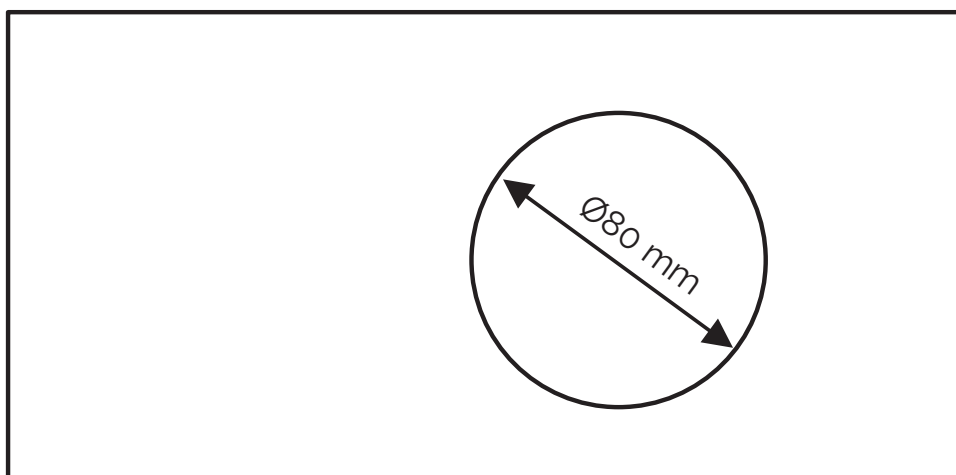

Asa Plastici srl
via Buonarroti, 58/60
20090 | Trezzano S/N (MI) | Italy
Tel/Phone +39 02 4455894 | Fax +39 02 4450107
web@asaplastici.it
asaplastici.com

