

PROFIL LED SURFACE10 BC/UX 1000 BIAŁY MAL. /OP



Nawierzchniowe



Meblowe



max 10 mm



- ukryte mocowanie
- szeroka oferta akcesoriów, 7 typów kloszy



CE



Wzory przemysłowe EU



Wyprodukowane w Polsce



Kup produkt

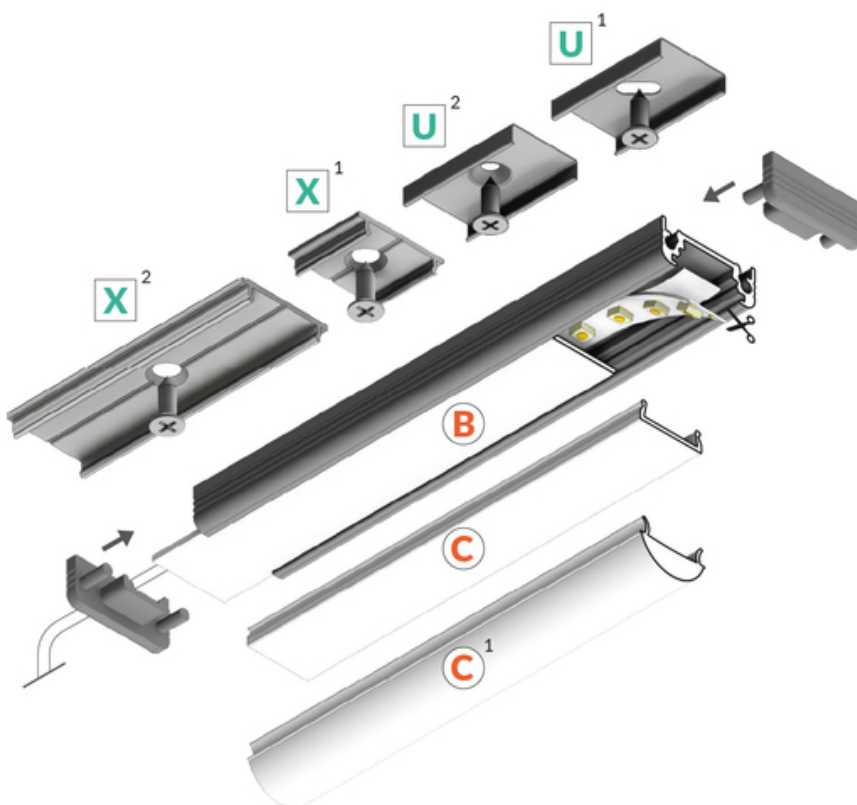
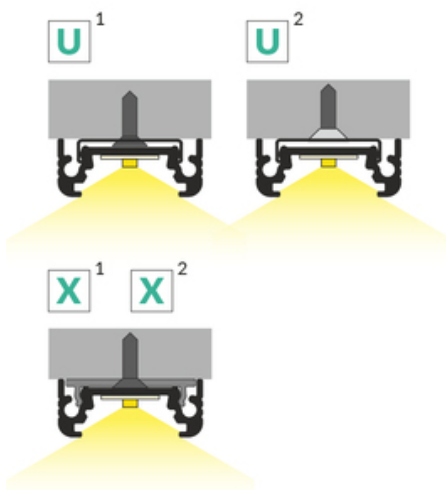
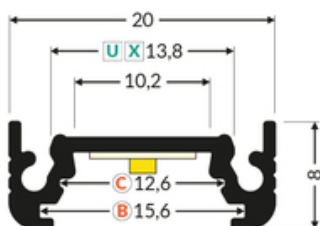

TOPMET LIGHT KŁOSOWICZ WIŚNIEWSKI sp. z o.o.

Ostrowska 354 | 61-312 Poznań | POLAND

tel.: +48 61 872 75 00

info@topmet.pl

data wygenerowania karty pdf: 29.08.2024

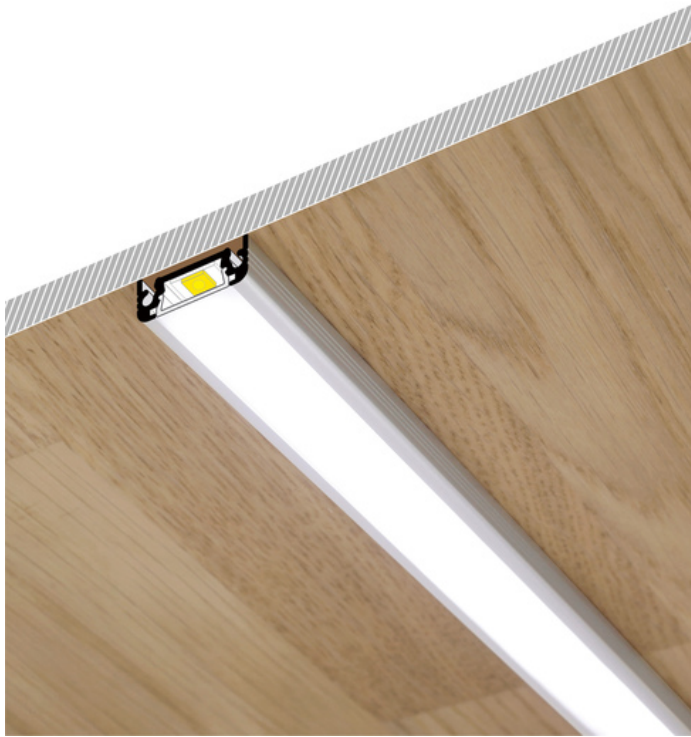

Informacje podstawowe

<p>Indeks: 77260001 EAN: 5901597203667 Materiał: aluminium Kolor: biały malowany Długość [mm]: 1000 Szerokość [mm]: 20 Wysokość [mm]: 8 Waga [kg]: 0.144 Waga opakowania [kg]: 0.012 Producent: TOPMET Kraj pochodzenia, wytworzenia: PL</p>	<p>Jednostka miary: szt. Typ opakowania jednostkowego: folia POF Wymiary opakowania jednostkowego [mm]: 1000 x 20 x 8 Opakowanie zbiorcze [szt]: 50 Typ opakowania zbiorczego: karton Waga produktu z opakowaniem zbiorczym [kg]: 7.61</p>
--	--

DOSTĘPNE KOLORY

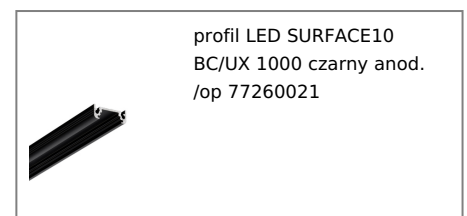
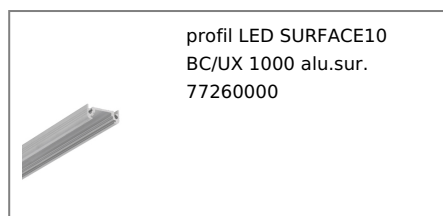
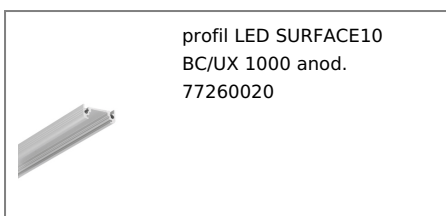

DOSTĘPNE WARIANTY

1000 mm, 2000 mm, 3000 mm, 4050 mm

Dopasowane elementy

KLOSZE DO PROFILI LED

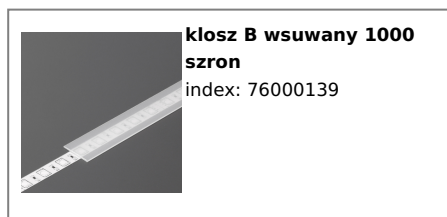
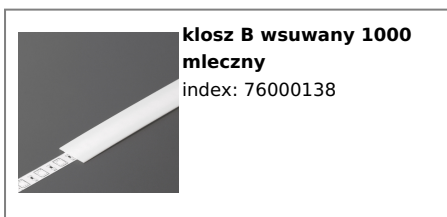

ZASLEPKI DO PROFILI LED

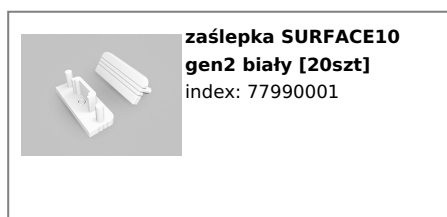

ŁĄCZNIKI DO PROFILI LED



UCHWYTY DO PROFILI LED



uchwyt U cone inox
[20szt]

index: 76620000

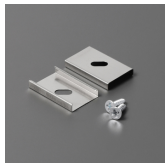

uchwyt U inox [20szt]

index: 76380000



uchwyt X [20szt]

index: 76260000