

Convertible rooms – just how you like it.

Hawa Concepta III Family



Hawa Concepta III

Hawa Folding Concepta III

On furniture: Sliding solution for furniture doors which can be pivoted, folded, pushed in and parked in a very small space at the side.

Hawa Concepta III family

Redesign of the pivot and folding/ slide-in doors

Designing hardware and systems that are optimally coordinated with current user requirements: In order to do this, Hawa Sliding Solutions is always prepared to go in new directions.

The newly designed Hawa Concepta III family is the perfect example of this. It follows an innovative basic approach: Only making rooms visible when they are needed. Contemporary trends such as lack of urban living space and the associated demand for using living areas in an economical and multi-functional way have been anticipated perfectly in this way.

This is because the Hawa Concepta III and the Hawa Folding Concepta III make it possible to conjure up an office or an entire kitchen from virtually nothing, and make it disappear again. And they reveal themselves to be space economy experts by requiring very little room in the parked position.



The combination of the two systems creates new, exciting design possibilities.



More aesthetics

Design is also always that which you don't see: With the new Hawa Concepta III family, work surfaces and entire kitchens can be reduced to an elegant, flush front with an even gap pattern. If you prefer a puristic appearance, you can even dispense with handles.



More comfort

Making the contents of a cabinet disappear within seconds only requires a minimal amount of effort with the Hawa Concepta III technology. The pioneering, patented system guarantees an even, extremely smooth movement with its sophisticated operating assistance.

More efficiency

The qualities of the Hawa Concepta III family are already evident during processing. The high degree of pre-assembly makes installation easier, and the logically positioned, easily accessible adjusting points simplify adjustment, and the entire system therefore supports increased productivity.

Wide range of design options

Rooms have never been as flexible as this

The Hawa Concepta systems of the newest generation display their full quality in the kitchen. They make floor-to-ceiling designs, highboards or wall units with two, three or four doors possible. This gives you almost unlimited creative freedom.

Height	Hawa Concepta III		Hawa Folding Concepta III	
2850				
2700				
2500				
2300	Running gear	Running gear	Running gear	Running gear
2200				
1900				
1850				
1250				
1200				
Weight	25	35	20	25

Combinations at your fingertips

A solution for every application

The Hawa Concepta III and the Hawa Folding Concepta III can be flexibly combined and implemented in made-to-measure dimensions. In this way, they make variable design solutions possible which are tailored exactly to the room and the type of use.

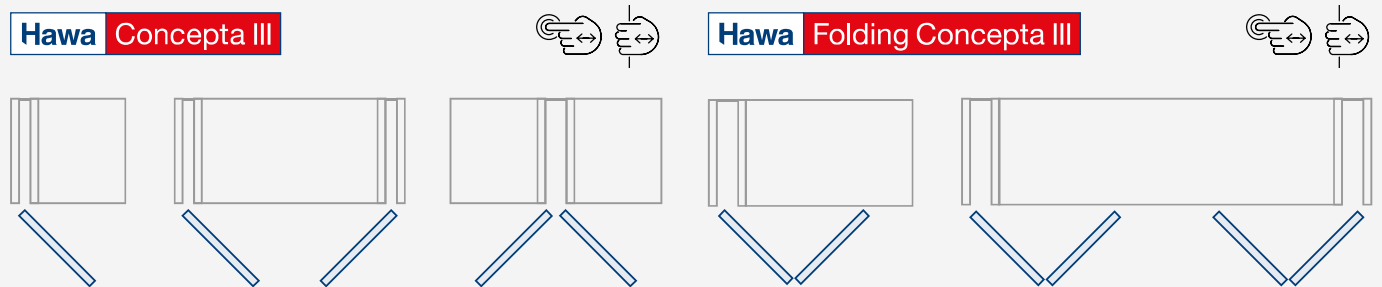

Open room layout

Washroom, wardrobe, home office or kitchen: The users are free to determine what is usable or visible.



Free access

No doors protruding into the room or standing in the way: This is the guarantee of unrestricted usage.



Large areas

Multi-leaf systems and door heights of up to 2700 mm: This is how entire cabinets and single-line kitchens can be made to disappear and reappear again.

Pivot and folding/slide-in hardware offers many advantages

The new Hawa Concepta III family in brief



Flexibility

Variable door dimensions: half-height to floor-to-ceiling solutions possible, including walk-on solutions

Hawa Concepta III and Hawa Folding Concepta III can be combined, for three-door solutions without separating wall



Comfort

Ergonomic movement support for even, smooth movement

Opening and closing with very little effort – one hand is enough



Security

Tested for 40,000 cycles (highest class) and maintenance-free for the entire service life (equivalent to approx. 25 years and the average service life of a pivot/slide-in door) (DIN EN 15706)



Productivity

Efficient planning with the Hawa configurator

Easy installation thanks to high degree of pre-assembly

Intuitive adjustment with easily accessible adjustment points



Aesthetics

Allows constructions with and without handle

Uniform, flush front design with even gap pattern

Invisible technology

Technical product information

You will find all of the necessary ordering information for the Hawa Concepta III and Hawa Folding Concepta III on the following pages.

Hawa Concepta III 25 Push see page 7

Hawa Concepta III 25 Pull see page 14

Hawa Concepta III 35 Push see page 21

Hawa Concepta III 35 Pull see page 28

Hawa Folding Concepta III 20 Push see page 35



Hawa Folding Concepta III 20 Pull see page 49

Hawa Folding Concepta III 25 Push see page 63





Hawa Folding Concepta III 25 Pull see page 77

Hardware for pivoting and lateral sliding in of wooden doors up to 35 kg (77 lbs.). Uniform, flush front design with even gap pattern. Pull version with handle and integrated soft closing mechanism.

Product highlights

-  **Productivity** Easy installation thanks to high degree of pre-assembly with intuitive adjustment
-  **Comfort** Ergonomic movement support for even, smooth movement
-  **Aesthetics** Allows constructions with and without handle – the technology remains invisible

Technical specifications

-  10–35 kg (22 to 77 lbs.)
-  1900–2700 mm (6' 2 13/16" to 8' 10 5/16")
-  440–750 mm (1' 5 5/16" to 2' 5 17/32")
-  18–26 mm (23/32" to 1 1/32")

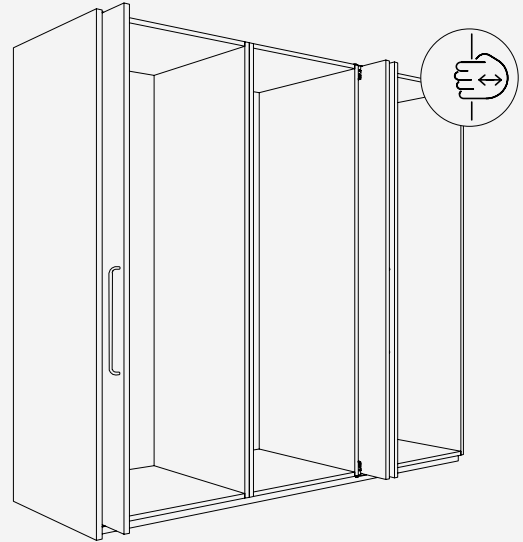

Installation examples

Door striking against the top and bottom cabinet sections

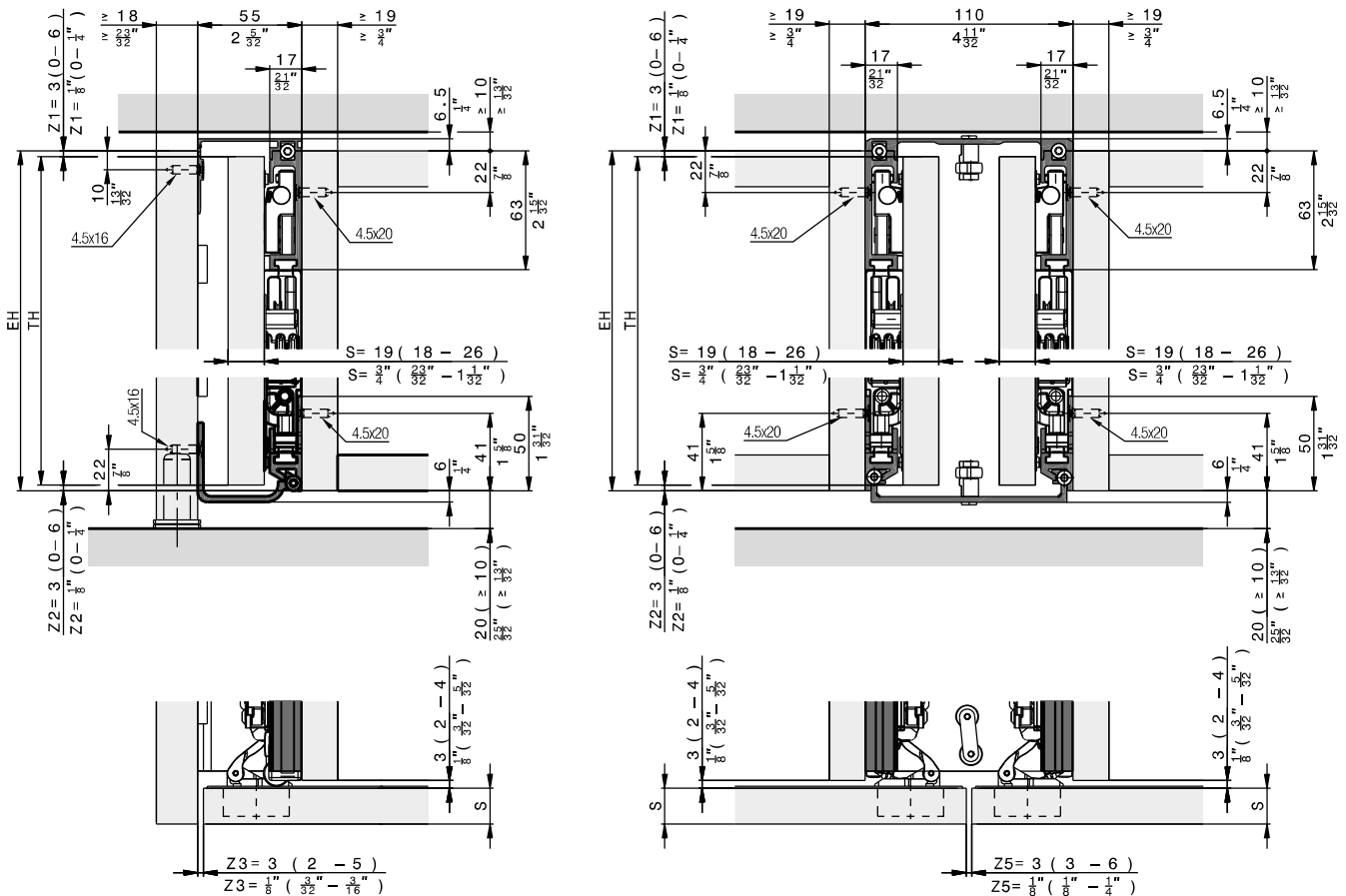

Components required for one cabinet

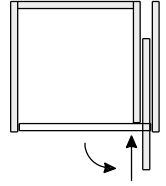
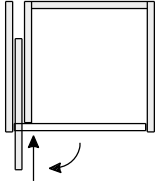

Hawa Concepta III 35 Pull, left

	No.
Hawa Concepta III 35, basic set left, door height 1900–2700 mm (6' 2 13/16" to 8' 10 5/16")	30996
Hawa Concepta III 25/35, Pull slide-in set, left	31000
Upright profile L= 2474 mm (8' 1 13/32"), for door height 1900–2700 mm (6' 2 13/16" to 8' 10 5/16"), aluminum, anodized	30771

Hawa Concepta III 35 Pull, right

	No.
Hawa Concepta III 35, basic set right, door height 1900–2700 mm (6' 2 13/16" to 8' 10 5/16")	30997
Hawa Concepta III 25/35, Pull slide-in set, right	31001
Upright profile L= 2474 mm (8' 1 13/32"), for door height 1900–2700 mm (6' 2 13/16" to 8' 10 5/16"), aluminum, anodized	30771

Weight and door size ratio calculations

The maximum weight must be adapted depending on the door size ratio.

DE Türbreite / FR Largeur de porte / EN Door width / IT Larghezza anta / ES Ancho de puerta

	440	500	550	600	650	700	750
2700	35	35	35	35	35	35	35
2650	35	35	35	35	35	35	35
2600	35	35	35	35	35	35	35
2550	35	35	35	35	35	35	35
2500	35	35	35	35	35	35	35
2450	35	35	35	35	35	35	34
2400	35	35	35	35	35	35	33
2350	35	35	35	35	35	34	32
2300	35	35	35	35	35	34	31
2250	35	35	35	35	35	33	31
2200	35	35	35	35	34	32	30
2150	35	35	35	35	33	31	29
2100	35	35	35	35	32	30	28
2050	35	35	35	34	31	29	27
2000	35	35	35	33	30	28	26
1950	35	35	35	32	29	27	26
1900	35	35	34	31	29	27	25

DE Maximale Gewichte in kg / FR Poids maximale en kg / EN Maximum weights in kg / IT Pesi massimo in kg / ES Pesos máximos en kg

	1' 5 5/16"	1' 7 11/16"	1' 9 21/32"	1' 11 5/8"	2' 1 19/32"	2' 3 9/16"	2' 5 17/32"
8' 10 5/16"	77	77	77	77	77	77	77
8' 8 11/32"	77	77	77	77	77	77	77
8' 6 3/8"	77	77	77	77	77	77	77
8' 4 13/32"	77	77	77	77	77	77	77
8' 2 7/16"	77	77	77	77	77	77	77
8' 0 15/32"	77	77	77	77	77	77	75
7' 10 1/2"	77	77	77	77	77	77	73
7' 8 17/32"	77	77	77	77	77	75	71
7' 6 9/16"	77	77	77	77	77	75	68
7' 4 19/32"	77	77	77	77	77	73	68
7' 2 5/8"	77	77	77	77	75	71	66
7' 0 21/32"	77	77	77	77	73	68	64
6' 10 11/16"	77	77	77	77	71	66	62
6' 8 23/32"	77	77	77	75	68	64	60
6' 6 3/4"	77	77	77	73	66	62	57
6' 4 25/32"	77	77	77	71	64	60	57
6' 2 13/16"	77	77	75	68	64	60	55

DE Maximale Gewichte in lbs. / FR Poids maximale en lbs. / EN Maximum weights in lbs. / IT Pesi massimo in lbs. / ES Pesos máximos en lbs.

DE Türgewicht in kg / FR Poids de porte en kg / EN Door weight in kg / IT Peso anta in kg / ES Peso de puerta en kg

DE Türgewicht in lbs. / FR Poids de porte en lbs. / EN Door weight in lbs. / IT Peso anta in lbs. / ES Peso de puerta en lbs.

Hawa Configurator













www.hawa.com/configurator



List of individual parts, which are included in the sets





Set for 1 pivot /slide-in door up to 35 kg (77 lbs.)

	No.
Hawa Concepta III 35, basic set left, door height 1900–2700 mm (6' 2 13/16" to 8' 10 5/16")	30996
Hawa Concepta III 35, basic set right, door height 1900–2700 mm (6' 2 13/16" to 8' 10 5/16")	30997

	30996	30997	No.
Set consisting of:			
	4	4	30686
	1	1	30738
	4	4	31070
	1	1	30811
	2	2	30983
	1	1	30986
	1		30805
	1		31059
	1	1	30810
	1	1	31047
		1	30806
		1	31060

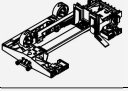
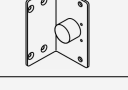
Suitable slide-in set

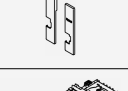
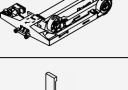
	No.
Hawa Concepta III 25/35, Pull slide-in set, left	31000
Hawa Concepta III 25/35, Pull slide-in set, right	31001

	31000	31001	No.
Set consisting of:			
	1		31040
	1	1	31414
	1	1	31221
	1		30964
		1	31041
		1	30965

Cabinet connecting parts

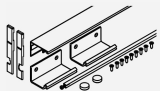
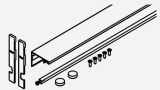
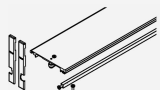
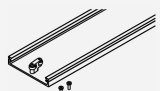
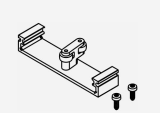
		mm (inch)	No.
	Connector set 55 mm (2 5/32"), for exterior connection to cabinet	560 (1' 10 1/16")	31005
	Connector top 55 mm (2 5/32"), for exterior connection to cabinet	560 (1' 10 1/16")	31430
	Connector top 110 mm (4 11/32"), for two pivot/slide-in doors	500 (1' 7 11/16")	31006
	Connector bottom 110 mm (4 11/32"), for two pivot/slide-in doors	500 (1' 7 11/16")	31246
	Connector bottom 110 mm (4 11/32"), for two pivot/slide-in doors (for installation in front of fixed plinth)	26 (1 1/32")	31007

Guides

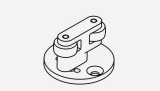
		No.
	Guide for two inset pivot sliding doors, aluminum	25680

Accessories

		No.
	Support for Halemeier automatic shut-off device Matching push button item 36 979 01 for Halemeier automatic shut-off device (Safety Box)	31020

Straightening fitting

→ Details under accessories frame page 323

Aluminum, untreated

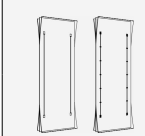
		Nr.
	Straightening fitting for doors 2040–2600 mm (6' 8 5/16" to 8' 6 3/8"), aluminum	056.3192.072
	Straightening fitting for doors 1715–2275 mm (3' 11 27/32" to 5' 9 7/8"), aluminum	056.3192.079

Aluminum, anodized

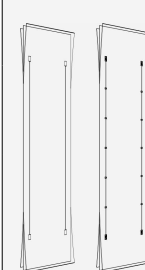
		No.
	Straightening fitting for doors 2240–2850 mm (7' 4 3/16" to 9' 4 7/32"), aluminum, anodized	056.3192.071
	Straightening fitting for doors 2040–2600 mm (6' 8 5/16" to 8' 6 3/8"), aluminum, anodized	056.3192.082
	Straightening fitting for doors 1715–2275 mm (5' 7 17/32" to 7' 5 9/16"), aluminum, anodized, can be shortened for doors 1215–1715 mm (3'11 27/32" to 5' 7 17/32")	056.3192.080

Aluminum, black anodized

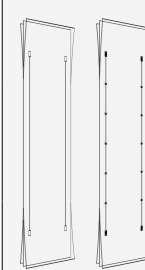
		No.
	Straightening fitting for doors 2240–2850 mm (7' 4 3/16" to 9' 4 7/32"), aluminum, black anodized	056.3192.074
	Straightening fitting for doors 2040–2600 mm (6' 8 5/16" to 8' 6 3/8"), aluminum, black anodized	056.3192.075
	Straightening fitting for doors 1715–2275 mm (5' 7 15/32" to 7' 5 9/16"), aluminum, black anodized	056.3192.081

Straightening fitting

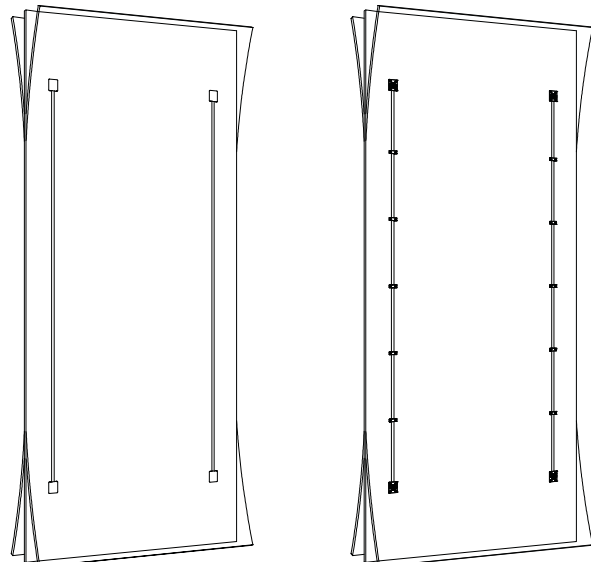

Further installation examples
Composed cabinet

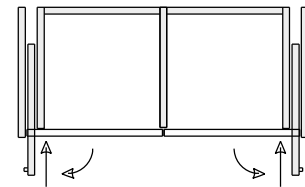
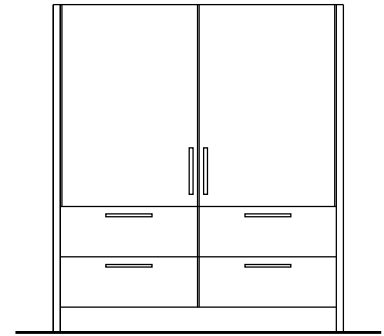
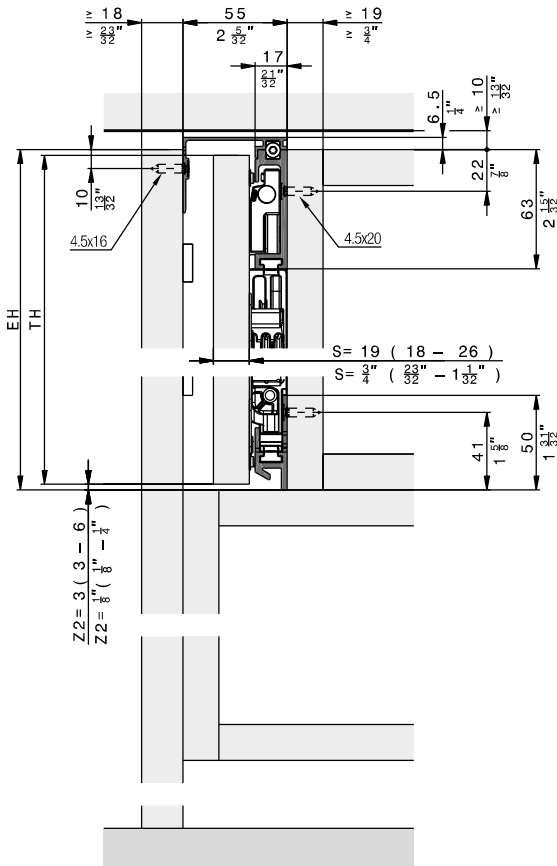

Cabinet without base panel

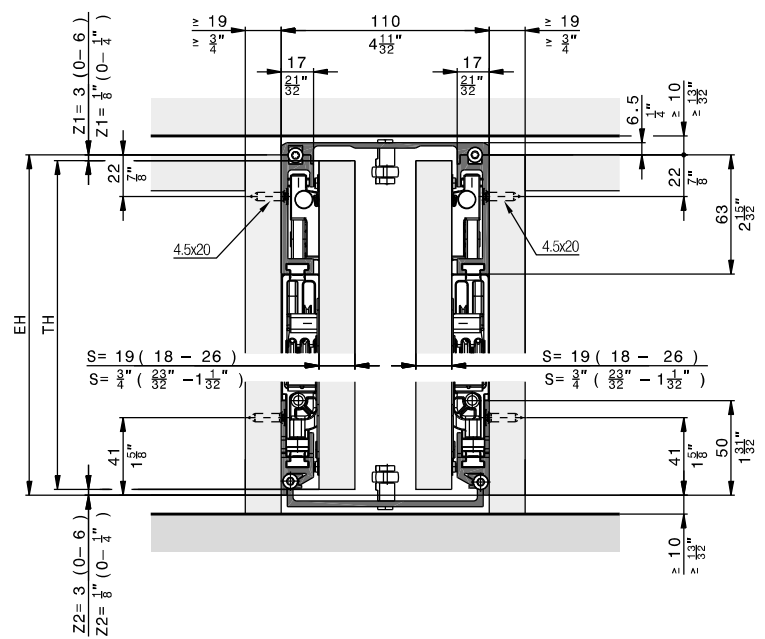
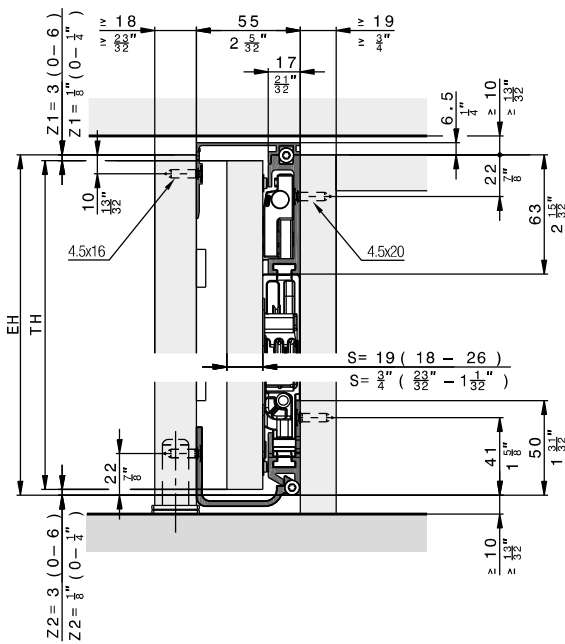

Inlaid doors

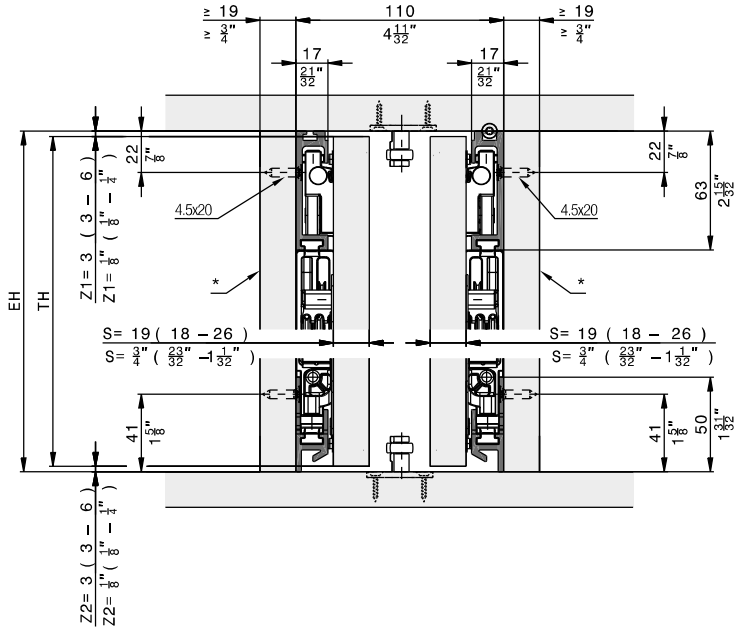
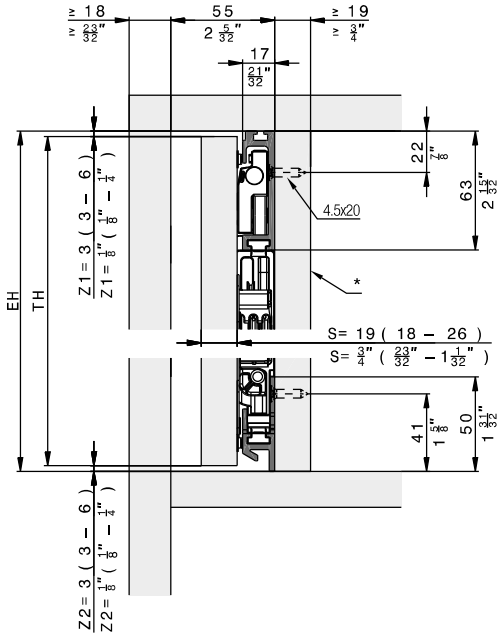

* removable

Floor-to-ceiling doors

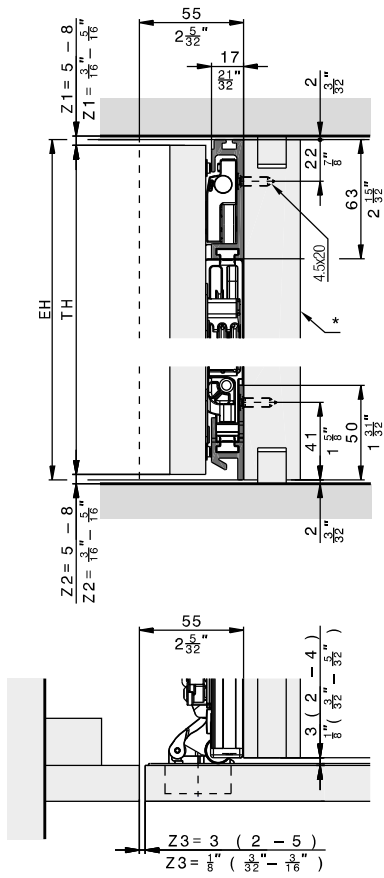

* removable

Hardware depth calculation

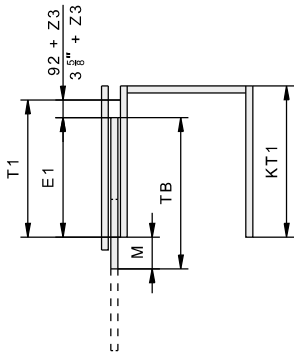

	mm	Inch
T1	≥ 414	≥ 1'4 ⁵ / ₁₆ "

	mm	Inch
T1	TB + 92 + Z3 - M	TB + 3 ⁵ / ₁₆ " + Z3 - M
E1	TB - M	TB - M
M	≥ S + 3 ≤ TB - 320	≥ S + ¹ / ₈ " ≤ TB - 1 ¹⁵ / ₃₂ "

Door flush with outer face

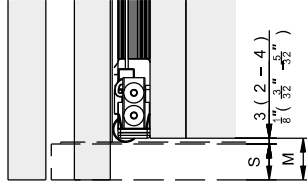

Protruding door

