

Convertible rooms – just how you like it.

Hawa Concepta III Family



Hawa Concepta III

Hawa Folding Concepta III

On furniture: Sliding solution for furniture doors which can be pivoted, folded, pushed in and parked in a very small space at the side.

Hawa Concepta III family

Redesign of the pivot and folding/ slide-in doors

Designing hardware and systems that are optimally coordinated with current user requirements: In order to do this, Hawa Sliding Solutions is always prepared to go in new directions.

The newly designed Hawa Concepta III family is the perfect example of this. It follows an innovative basic approach: Only making rooms visible when they are needed. Contemporary trends such as lack of urban living space and the associated demand for using living areas in an economical and multi-functional way have been anticipated perfectly in this way.

This is because the Hawa Concepta III and the Hawa Folding Concepta III make it possible to conjure up an office or an entire kitchen from virtually nothing, and make it disappear again. And they reveal themselves to be space economy experts by requiring very little room in the parked position.



The combination of the two systems creates new, exciting design possibilities.



More aesthetics

Design is also always that which you don't see: With the new Hawa Concepta III family, work surfaces and entire kitchens can be reduced to an elegant, flush front with an even gap pattern. If you prefer a puristic appearance, you can even dispense with handles.



More comfort

Making the contents of a cabinet disappear within seconds only requires a minimal amount of effort with the Hawa Concepta III technology. The pioneering, patented system guarantees an even, extremely smooth movement with its sophisticated operating assistance.

More efficiency

The qualities of the Hawa Concepta III family are already evident during processing. The high degree of pre-assembly makes installation easier, and the logically positioned, easily accessible adjusting points simplify adjustment, and the entire system therefore supports increased productivity.

Wide range of design options

Rooms have never been as flexible as this

The Hawa Concepta systems of the newest generation display their full quality in the kitchen. They make floor-to-ceiling designs, highboards or wall units with two, three or four doors possible. This gives you almost unlimited creative freedom.

Height	Hawa Concepta III		Hawa Folding Concepta III	
2850				
2700				
2500				
2300	Running gear	Running gear	Running gear	Running gear
2200				
1900				
1850				
1250				
1200				
Weight	25	35	20	25

Combinations at your fingertips

A solution for every application

The Hawa Concepta III and the Hawa Folding Concepta III can be flexibly combined and implemented in made-to-measure dimensions. In this way, they make variable design solutions possible which are tailored exactly to the room and the type of use.

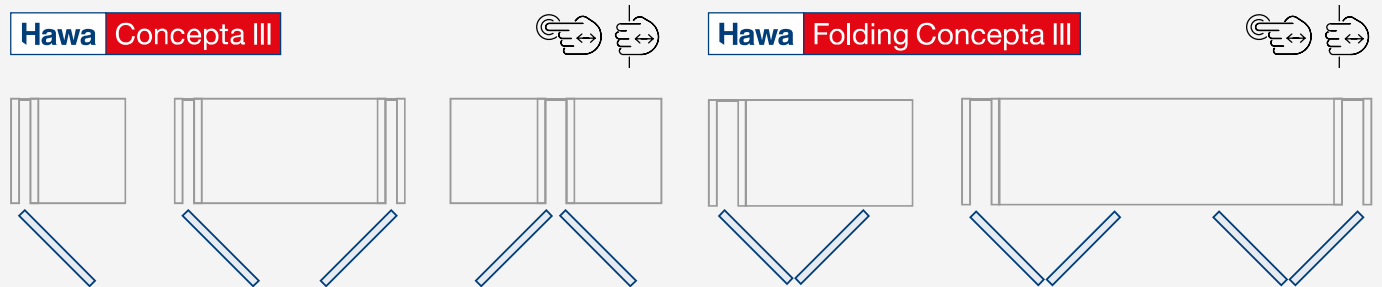

Open room layout

Washroom, wardrobe, home office or kitchen: The users are free to determine what is usable or visible.



Free access

No doors protruding into the room or standing in the way: This is the guarantee of unrestricted usage.



Large areas

Multi-leaf systems and door heights of up to 2700 mm: This is how entire cabinets and single-line kitchens can be made to disappear and reappear again.

Pivot and folding/slide-in hardware offers many advantages

The new Hawa Concepta III family in brief



Flexibility

Variable door dimensions: half-height to floor-to-ceiling solutions possible, including walk-on solutions

Hawa Concepta III and Hawa Folding Concepta III can be combined, for three-door solutions without separating wall



Comfort

Ergonomic movement support for even, smooth movement

Opening and closing with very little effort – one hand is enough



Security

Tested for 40,000 cycles (highest class) and maintenance-free for the entire service life (equivalent to approx. 25 years and the average service life of a pivot/slide-in door) (DIN EN 15706)



Productivity

Efficient planning with the Hawa configurator

Easy installation thanks to high degree of pre-assembly

Intuitive adjustment with easily accessible adjustment points



Aesthetics

Allows constructions with and without handle

Uniform, flush front design with even gap pattern

Invisible technology

Technical product information

You will find all of the necessary ordering information for the Hawa Concepta III and Hawa Folding Concepta III on the following pages.

Hawa Concepta III 25 Push see page 7

Hawa Concepta III 25 Pull see page 14

Hawa Concepta III 35 Push see page 21

Hawa Concepta III 35 Pull see page 28

Hawa Folding Concepta III 20 Push see page 35



Hawa Folding Concepta III 20 Pull see page 49

Hawa Folding Concepta III 25 Push see page 63





Hawa Folding Concepta III 25 Pull see page 77

**Fitting for pivoting and lateral sliding in of wooden doors up to 25 kg (55 lbs.).
Uniform, flush front design with even gap pattern. Push-to-open function for
handle-less cabinet designs.**

Product highlights

-  **Productivity** Easy installation thanks to high degree of pre-assembly with intuitive adjustment
-  **Comfort** Ergonomic movement support for even, smooth movement
-  **Aesthetics** Cabinet designs without handle – the technology remains invisible

Technical specifications

-  6–25 kg (13 to 55 lbs.)
-  1200–2200 mm (3' 11 1/4" to 7' 2 5/8")
-  440–750 mm (1' 5 5/16" to 2' 5 17/32")
-  18–26 mm (23/32" to 1 1/32")



Installation examples

Door striking against the top and bottom cabinet sections

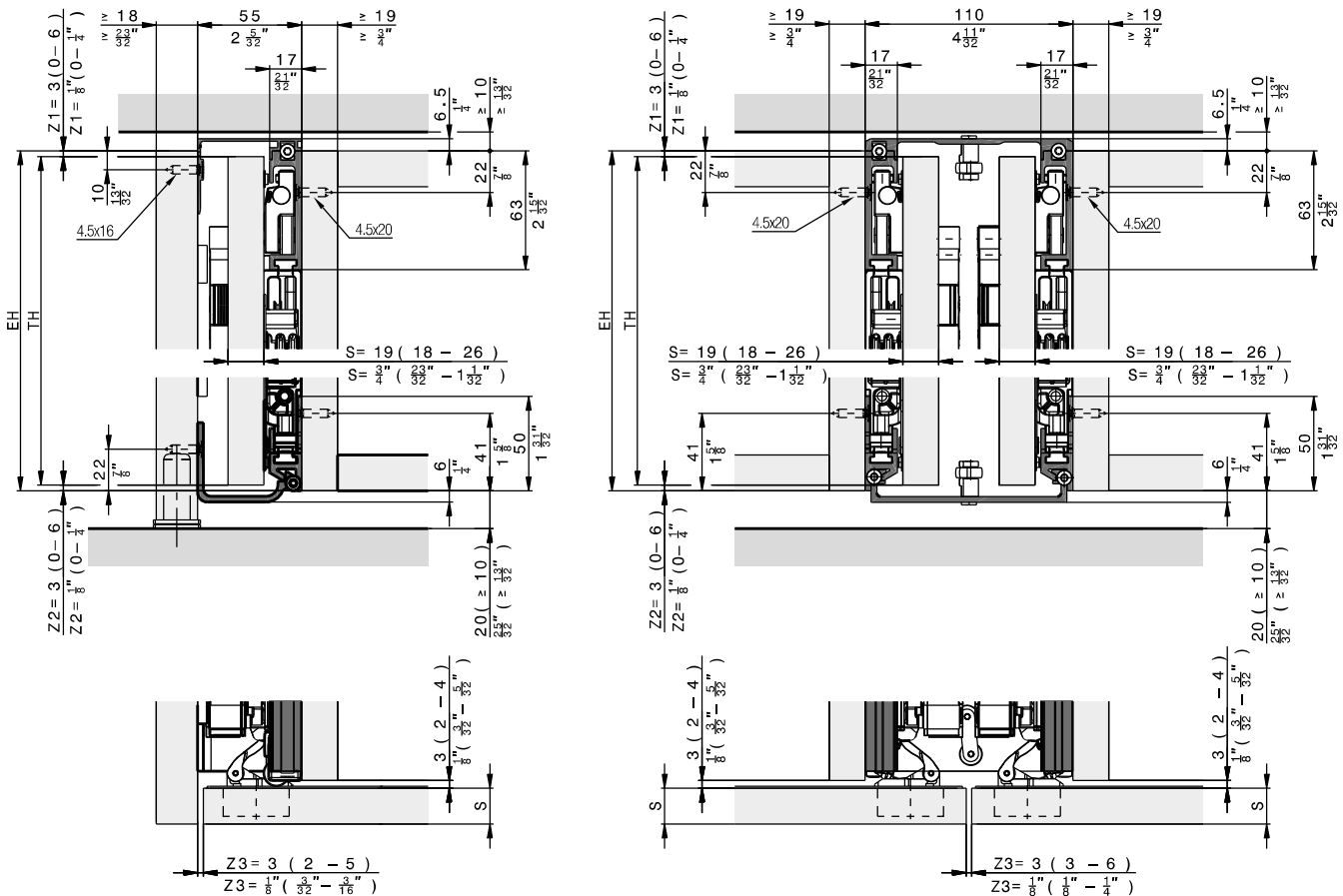

Components required for one cabinet

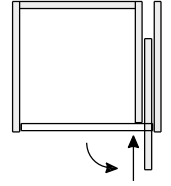
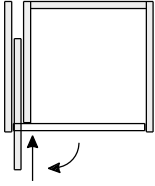

Hawa Concepta III 25 Push, left

	No.
Hawa Concepta III 25, basic set left, door height 1200–2200 mm (3' 11 1/4" to 7' 2 5/8")	30994
Hawa Concepta III 25/35, Push slide-in set, left	30998
Upright profile L= 1974 mm (6' 5 23/32"), for door height 1200–2200 mm (3' 11 1/4" to 7' 2 5/8"), aluminum, anodized	30778

Hawa Concepta III 25 Push, right

	No.
Hawa Concepta III 25, basic set right, door height 1200–2200 mm (3' 11 1/4" to 7' 2 5/8")	30995
Hawa Concepta III 25/35, Push slide-in set, right	30999
Upright profile L= 1974 mm (6' 5 23/32"), for door height 1200–2200 mm (3' 11 1/4" to 7' 2 5/8"), aluminum, anodized	30778

Weight and door size ratio calculations

The maximum weight must be adapted depending on the door size ratio.

DE Türbreite / FR Largeur de porte / EN Door width / IT Larghezza anta / ES Ancho de puerta

	440	500	550	600	650	700	750
2200	25	25	25	25	25	25	24
2150	25	25	25	25	25	25	23
2100	25	25	25	25	25	24	23
2050	25	25	25	25	25	24	22
2000	25	25	25	25	25	23	21
1950	25	25	25	25	24	22	21
1900	25	25	25	25	23	21	20
1850	25	25	25	24	22	21	19
1800	25	25	25	23	21	20	19
1750	25	25	25	22	21	19	18
1700	25	25	24	22	20	19	17
1650	25	25	23	21	19	18	17
1600	25	24	22	20	18	17	16
1550	25	23	21	19	18	16	15
1500	24	22	20	18	17	16	15
1450	23	21	19	17	16	15	14
1400	22	20	18	17	15	14	13
1350	21	19	17	16	15	14	13
1300	20	18	16	15	14	13	12
1250	19	17	15	14	13	12	11
1200	18	16	15	13	12	11	11

DE Maximale Gewichte in kg / FR Poids maximale en kg / EN Maximum weights in kg / IT Pesi massimo in kg / ES Pesos máximos en kg

DE Türhöhe / FR Hauteur de porte / EN Door height / IT Altezza anta / ES Altura de puerta

DE Türgewicht in kg / FR Poids de porte en kg / EN Door weight in kg / IT Peso anta in kg / ES Peso de puerta en kg

	1' 5 5/16"	1' 7 11/16"	1' 9 21/32"	1' 11 5/8"	2' 1 19/32"	2' 3 9/16"	2' 5 17/32"
7' 2 9/16"	55	55	55	55	55	55	53
7' 0 21/32"	55	55	55	55	55	55	51
6' 10 11/16"	55	55	55	55	55	53	51
6' 8 23/32"	55	55	55	55	55	53	49
6' 6 3/4"	55	55	55	55	55	51	46
6' 4 25/32"	55	55	55	55	53	49	46
6' 2 13/16"	55	55	55	55	51	46	44
6' 0 27/32"	55	55	55	53	49	46	42
5' 10 7/8"	55	55	55	51	46	44	42
5' 8 29/32"	55	55	55	49	46	42	40
5' 6 15/16"	55	55	53	49	44	42	37
5' 4 31/32"	55	55	51	46	42	40	37
5' 3"	55	53	49	44	40	37	35
5' 1 1/32"	55	51	46	42	40	35	33
4' 11 1/16"	53	49	44	40	37	35	33
4' 9 3/8"	51	46	42	37	35	33	31
4' 7 1/8"	49	44	40	37	33	31	29
4' 5 5/8"	46	42	37	35	33	31	29
4' 3 3/16"	44	40	35	33	31	29	26
4' 1 7/32"	42	37	33	31	29	26	24
3' 11 1/4"	40	35	33	29	26	24	24

DE Maximale Gewichte in lbs. / FR Poids maximale en lbs. / EN Maximum weights in lbs. / IT Pesi massimo in lbs. / ES Pesos máximos en lbs.

DE Türgewicht in lbs. / FR Poids de porte en lbs. / EN Door weight in lbs. / IT Peso anta in lbs. / ES Peso de puerta en lbs.











Hawa Configurator

www.hawa.com/configurator →

List of individual parts, which are included in the sets

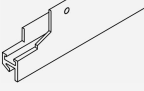



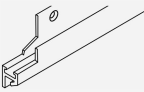
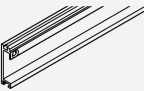

Set for 1 pivot /slide-in door up to 25 kg (55 lbs.)

	No.
Hawa Concepta III 25, basic set left, door height 1200–2200 mm (3' 11 1/4" to 7' 2 5/8")	30994
Hawa Concepta III 25, basic set right, door height 1200–2200 mm (3' 11 1/4" to 7' 2 5/8")	30995

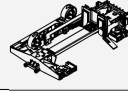
	30994	30995	No.
Set consisting of:			
 Slot nuts for hinge attachment, plastic, black	3	3	30686
 Mounting plate for hinge with height adjustment, steel, nickel-plated	1	1	30738
 Concealed hinge, with soft closing mechanism and closing spring, steel, nickel plated	3	3	31070
 Set for concealed hinges, 8 screws 4x16 mm (5/32"x5/8"), 3 door stop buffers	1	1	30811
 Profile for magnetic guide, with double-sided adhesive tape, steel, black, L=730 mm (2' 4 3/4")	2	2	30983
 Euro screw, 6x13 mm (1/4"x1/2"), steel, black, set of 6 pieces	1	1	30986
 Bottom guide track left, aluminum, anodized, L= 838 mm (2' 9")	1		30805
 Top running track left, aluminum, anodized, L= 838 mm (2' 9")	1		31059
 Countersunk head screw, 4.5x20 mm (5/32"x25/32"), steel, zinc-plated, set of 16 pieces	1	1	30810
 Set of adjusting tools	1	1	31047
 Bottom guide track right, aluminum, anodized, L= 838 mm (2' 9")		1	30806
 Top running track right, aluminum, anodized, L= 838 mm (2' 9")		1	31060

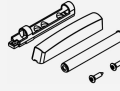
Suitable slide-in set

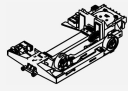
	No.
Hawa Concepta III 25/35, Push slide-in set, left	30998
Hawa Concepta III 25/35, Push slide-in set, right	30999

	30998	30999	No.
Set consisting of:			
 Hawa Concepta III 25/35 Push slide-in unit, left	1		31038
 End stop bracket for push ejector, steel, zinc-plated	1	1	31043
 Push ejector, plastic, black	1	1	31010
 Push-to-open with adapter plate, plastic, black	1	1	30838
 Hawa Concepta III Push set of cover caps, for left-hand stop, plastic, black	1		30818
 Hawa Concepta III 25/35 Push slide-in unit, right		1	31039
 Hawa Concepta III Push set of cover caps, for right-hand stop, plastic, black		1	30827

Cabinet connecting parts

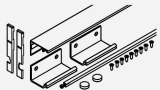
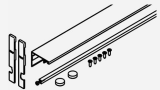
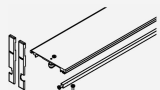
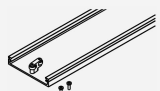
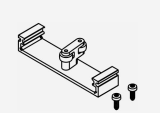
		mm (inch)	No.
	Connector set 55 mm (2 5/32"), for exterior connection to cabinet	560 (1' 10 1/16")	31005
	Connector top 55 mm (2 5/32"), for exterior connection to cabinet	560 (1' 10 1/16")	31430
	Connector top 110 mm (4 11/32"), for two pivot/slide-in doors	500 (1' 7 11/16")	31006
	Connector bottom 110 mm (4 11/32"), for two pivot/slide-in doors	500 (1' 7 11/16")	31246
	Connector bottom 110 mm (4 11/32"), for two pivot/slide-in doors (for installation in front of fixed plinth)	26 (1 1/32")	31007

Guides

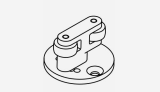
		No.
	Guide for two inset pivot sliding doors, aluminum	25680

Accessories

		No.
	Support for Halemeier automatic shut-off device Matching push button item 36 979 01 for Halemeier automatic shut-off device (Safety Box)	31020

Straightening fitting

→ Details under accessories from page 323

Aluminum, untreated

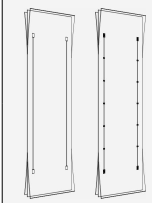
		No.
	Straightening fitting for doors 1715–2275 mm (3' 11 27/32" to 5' 9 7/8"), aluminum	056.3192.079
	Straightening fitting for doors 1215–1775 mm (3' 11 27/32" to 5' 9 7/8"), aluminum	056.3192.073

Aluminum, anodized

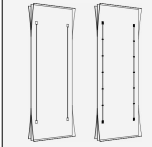
		Nr.
	Straightening fitting for doors 1715–2275 mm (5' 7 17/32" to 7' 5 9/16"), aluminum, anodized, can be shortened for doors 1215–1715 mm (3' 11 27/32" to 5' 7 17/32")	056.3192.080

Aluminum, black anodized

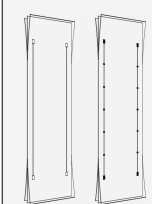
		No.
	Straightening fitting for doors 1715–2275 mm (5' 7 15/32" to 7' 5 9/16"), aluminum, black anodized	056.3192.081
	Straightening fitting for doors 1215–1775 mm (3' 11 27/32" to 5' 9 7/8"), aluminum, black anodized	056.3192.076

Straightening fitting

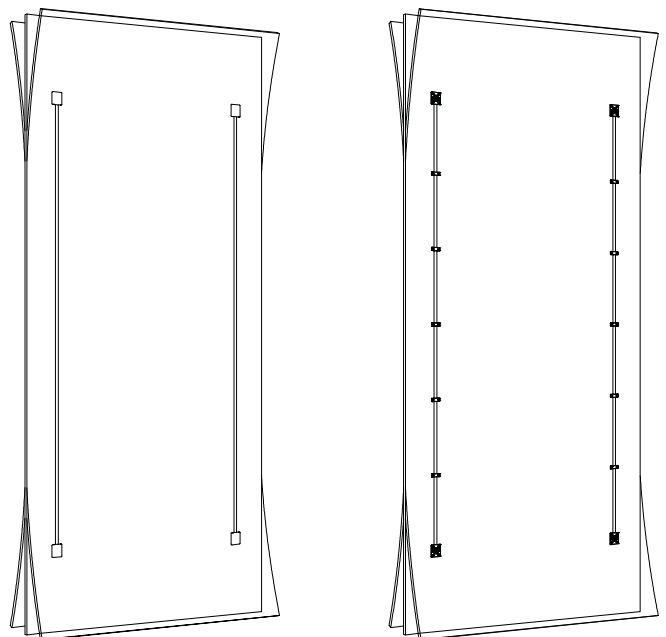

Further installation examples
Composed cabinet

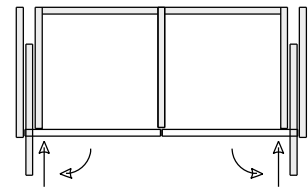
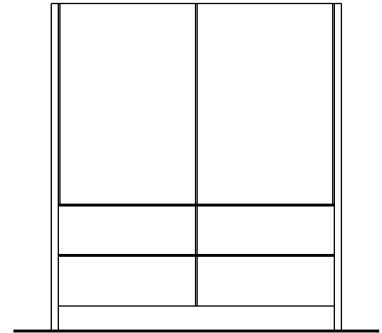
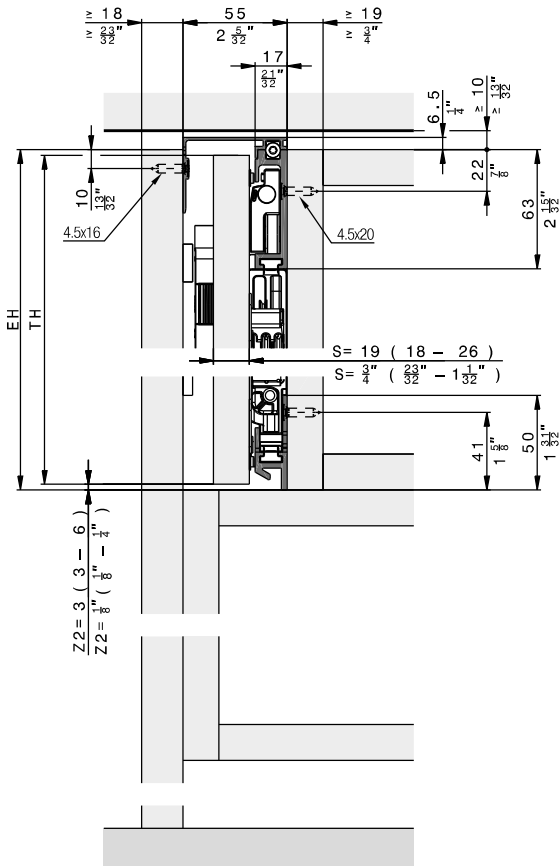

Cabinet without base panel

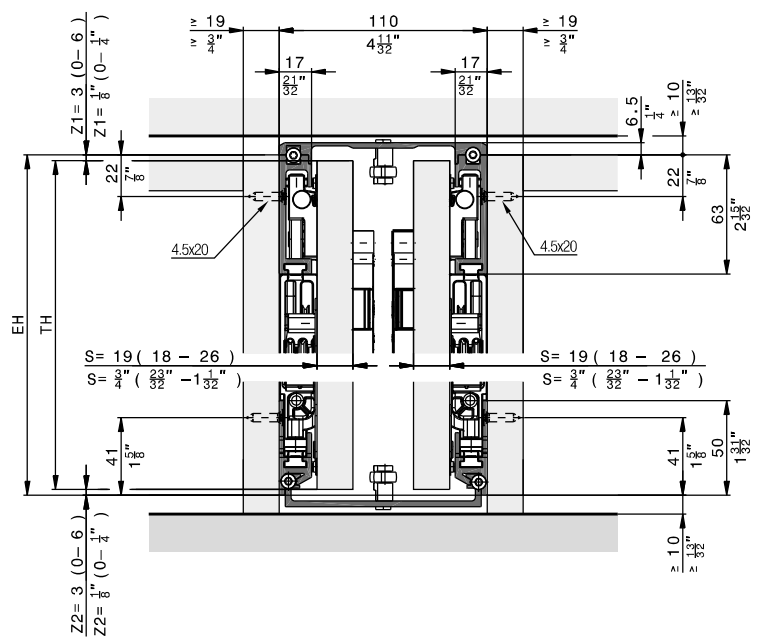
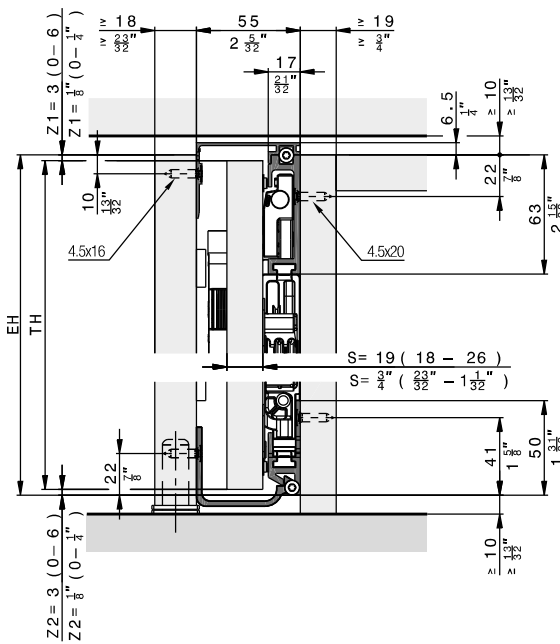

Inlaid doors

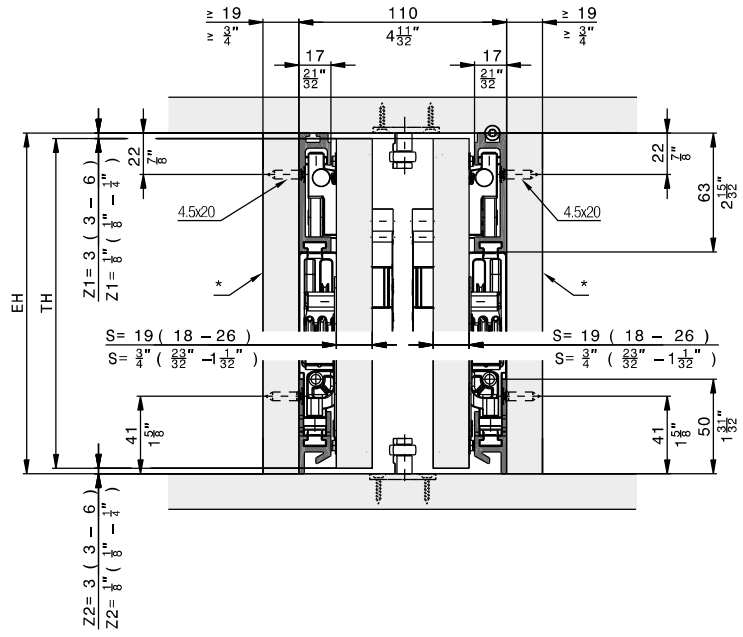
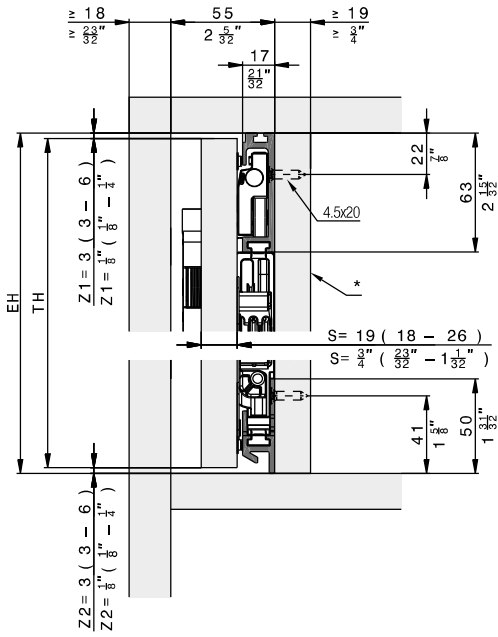

* removable

Floor-to-ceiling doors

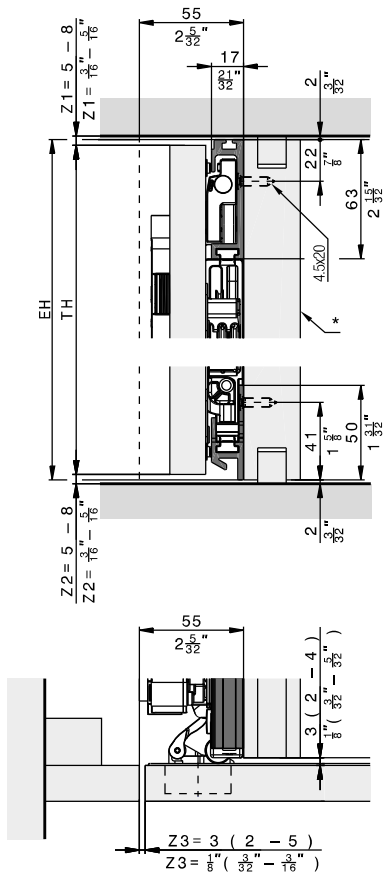

* removable

Hardware depth calculation

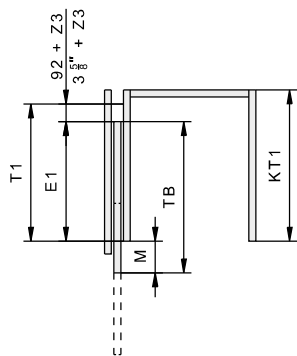

	mm	Inch
T1	≥ 414	≥ 1' 4 ⁵ / ₁₆ "

	mm	Inch
T1	TB + 92 + Z3 - M	TB + 3 ⁵ / ₁₆ " + Z3 - M
E1	TB - M	TB - M
M	≥ S + 3 ≤ TB - 320	≥ S + ¹ / ₈ " ≤ TB - 1 ¹⁵ / ₃₂ "

Door flush with outer face

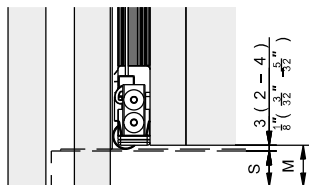

Protruding door

