







Fitting for top-running glass doors up to 100 kg (220 lbs.), with surface mounted running track or running track flush with the ceiling. Optionally with soft and self closing mechanism. Ceiling mounting.

Product highlights

-  **Flexibility** Wall mounting, ceiling integration or surface mounting on the ceiling possible
-  **Aesthetics** The technology is almost invisible, since it is contained within the ceiling-integrated running profile
-  **Aesthetics** Also available in black as a "Black Edition" design option for a particularly attractive appearance

Technical specifications

-  Max. 100 kg (220 lbs.)
-  Max. 2700 mm (8'10 5/16")
-  Max. 1600 mm (5'3")
-  8–12.7 mm (5/16" to 1/2")

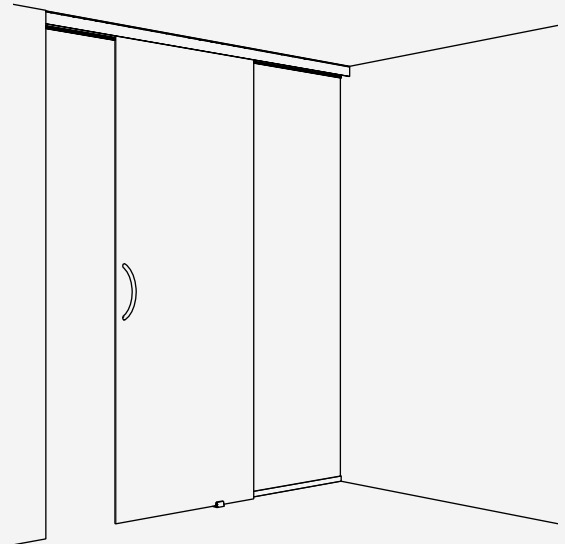



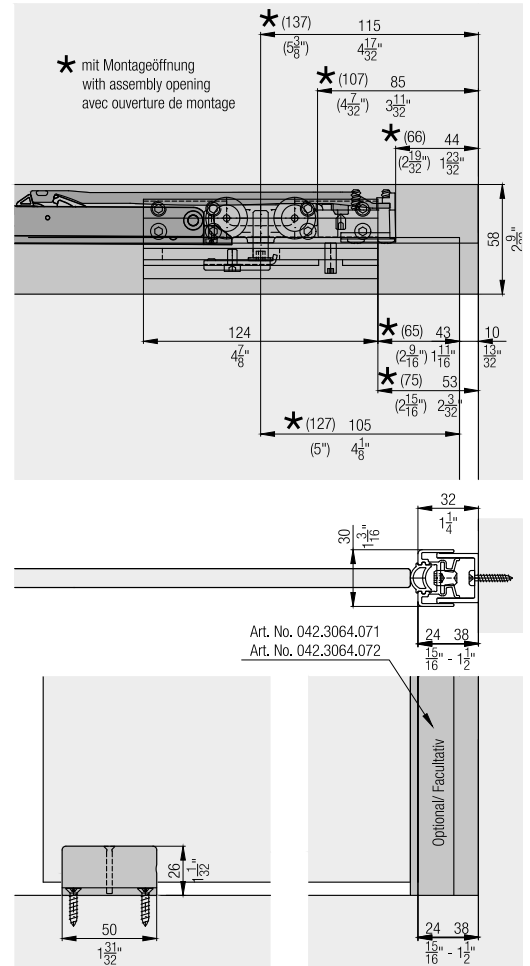
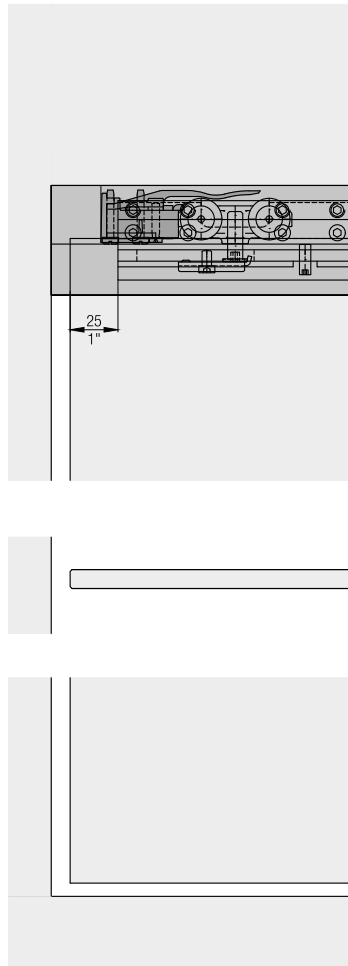
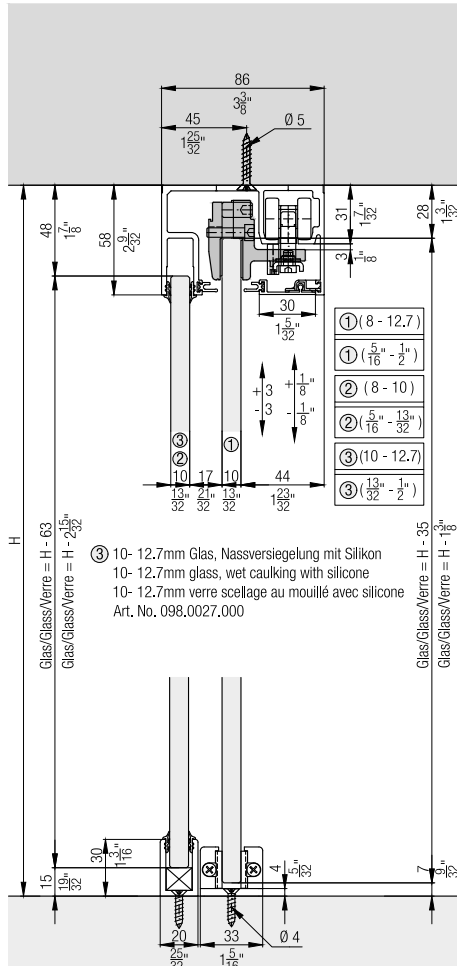





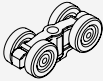
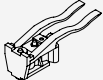

Installation examples

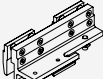
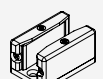

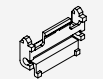

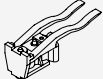
Set for ceiling or wall mounting, for 1 glass door up to 100 kg (220 lbs.)

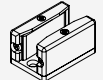
	No.
Hawa Porta 100 GW, for 1 door	057.3091.071
Hawa Porta 100 GWF, black, for 1 door	057.3091.075

Set consisting of:

	057.3091.071	057.3091.075	No.
 Running gear, ball bearing, rollers plastic white	2	2	057.3114.071
 Stopper, with retention spring, plastic, gray	1		057.3073.072
 Stopper, without retention spring, plastic, gray	1		057.3073.071
 Suspension bolt, M8x25 mm, flat head, steel, black	2	2	600.0000.473
 Clamping shoe, glass thickness 6–12.7 mm (1/4"–1/2"), aluminum	2	2	057.3087.071
 Bottom guide, play-free adjustable, glass thickness 8–12.7 mm (5/16"–1/2"), chrome-plated, mat	1		057.3082.071
 Wall buffer, 19x10 mm (3/4"x13/32"), rubber, black	1	1	024.0002.046
 Clip for panel, every 300 mm (11 13/16"), plastic, gray, 12-piece set	1	1	057.3086.051
 Countersunk head screw, 4x20 mm (5/32"x25/32"), steel, zinc-plated	3		766.5042.120
 Stopper, with retention spring, plastic, black	1		057.3073.076
 Stopper, without retention spring, plastic, black	1		057.3073.075
 Bottom guide, playfree adjustable, black	1		057.3082.075
 Countersunk head screw, 4x20 mm, steel, zinc-plated	3		600.0000.817



Running tracks

	mm (inch)	No.
	2,500 (8' 2 7/16")	057.3084.250
	3,500 (11' 5 25/32")	057.3084.350
	6,000 (19' 8 7/32")	057.3084.600
	cut to size	057.3084.990
	2,500 (8' 2 7/16")	057.3084.255
	3,500 (11' 5 25/32")	057.3084.355
	2,000 (6' 6 3/4")	057.3089.001
	cut to size	057.3089.990

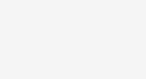

Front edge profiles

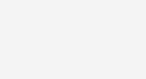
	mm (inch)	No.
	2,500 (8' 2 7/16")	042.3005.250
	3,000 (9' 10 1/8")	042.3005.300
	6,000 (19' 8 7/32")	042.3005.600
	cut to size	042.3005.990
	2,500 (8' 2 7/16")	042.3005.255

Panels

	mm (inch)	No.
	2,500 (8' 2 7/16")	057.3085.250
	3,500 (11' 5 25/32")	057.3085.350
	6,000 (19' 8 7/32")	057.3085.600
	cut to size	057.3085.990
	2,500 (8' 2 7/16")	057.3085.255
	3,500 (11' 5 25/32")	057.3085.355
	20,000 (65' 7 13/32")	057.3078.002



Fixed glass support profiles

		mm (inch)	No.
	Fixed glass profil/ guide track, aluminum, anodized, pre-drilled	2,500 (8' 2 7/16")	057.3056.250
		3,500 (11' 5 25/32")	057.3056.350
		6,000 (19' 8 7/32")	057.3056.600
		cut to size	057.3056.990
	Fixed glass profil/ guide track, aluminum, black anodized, pre-drilled	2,500 (8' 2 7/16")	057.3056.255
		3,500 (11' 5 25/32")	057.3056.355
		20,000 (65' 7 13/32")	057.3072.001

Set fixing set

	No.
Fixing set, aluminum, anodized, for fixed glass support profile 057.3057., fixed glass profil/guide track 057.3056.	057.3076.071
Fixing set, aluminum, black anodized, for fixed glass profil/guide track 057.3056.	057.3076.075



Set consisting of:

		057.3076.071	057.3076.075	No.
	Cover, aluminum, anodized	2		057.3062.001
	Thread rolling rounded head screw, M4x10 mm (5/32"x13/32"), steel, zinc-plated	15	15	762.7008.100
	Cover, aluminum, anodized black		2	057.3062.005

Soft close

For soft closing in opening and closing direction
order 2 sets.

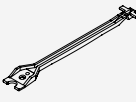

	No.
Soft close Hawa Porta 100, Divido 100, 61-100 kg (133-220 lbs.), 1 piece	042.3102.071
Soft close Hawa Porta 60/100, Divido 100, 10-60 kg (22-132 lbs.), 1 piece	042.3102.072

		042.3102.071	042.3102.072	No.
	Soft close, top running, 61-100 kg (133 to 220 lbs.), plastic	1		042.3106.071
	Trigger for soft close in buildings, zinc die casting	1	1	042.3105.001
	Screw set soft close	1	1	600.0000.566
	Soft close, top running, 10-60 kg (22 to 132 lbs.), plastic		1	042.3106.072

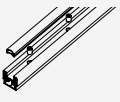
Wall compensation profiles

		mm (inch)	No.
	Wall compensation profile, with sealing profile gray, aluminum, anodized	2,500 (8' 2 7/16")	042.3064.071
		3,000 (9' 10 1/8 ")	042.3064.072

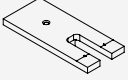
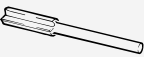
Accessories

		No.
	Bottom door stopper, with centering, chrome-plated, matt	20773
	Routing jig for assembly opening	042.3118.071
	Groove cutter to routing jig, Ø= 10 mm (13/32"), hard metal	600.0000.309
	Track cleaner, plastic, blue	057.3099.071

Ceiling integration

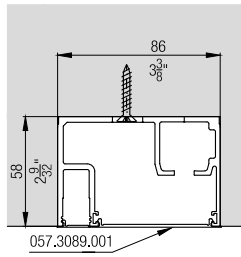
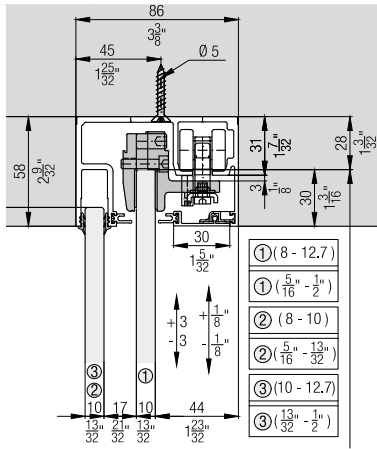

Bottom door stopper

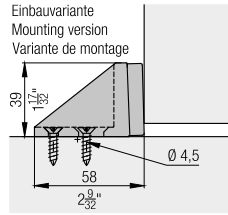

③ 10- 12.7mm Glas, Nassversiegelung mit Silikon
 10- 12.7mm glass, wet caulking with silicone
 10- 12.7mm verre scellage au mouillé avec silicone
 Art. No. 098.0027.000

Calculations

*	Z =					
	1		2		2	
	0	1	2	0	1	2
Hawa Porta 60/100 H/H/C	1' 6 ²⁹ / ₃₂ "	1' 9 ¹ / ₁₆ "	1' 11 ¹ / ₄ "	2' 4 ³ / ₄ "	2' 6 ²⁹ / ₃₂ "	2' 9 ³ / ₃₂ "
Hawa Porta 60/100 HM/HMD/HMT	1' 6 ²⁹ / ₃₂ "	1' 9 ¹ / ₁₆ "	1' 11 ¹ / ₄ "	2' 4 ³ / ₄ "	2' 6 ²⁹ / ₃₂ "	2' 9 ³ / ₃₂ "
Hawa Porta 100 G/GU/GM/GMT	1' 6 ²⁹ / ₃₂ "	1' 9 ¹ / ₁₆ "	1' 11 ¹ / ₄ "	2' 4 ³ / ₄ "	2' 6 ²⁹ / ₃₂ "	2' 9 ³ / ₃₂ "
Hawa Porta 100 GF	1' 6 ²⁹ / ₃₂ "			2' 4 ³ / ₄ "		
Hawa Porta 100 GW/GWF	1' 8 ⁵ / ₃₂ "	1' 9 ¹¹ / ₃₂ "	1' 11 ¹ / ₄ "	2' 6"	2' 6 ²⁹ / ₃₂ "	2' 7 ³ / ₁₆ "
Hawa Porta 100 GMD	1' 7 ⁷ / ₃₂ "	1' 9 ⁷ / ₃₂ "	1' 11 ¹ / ₄ "	2' 5 ¹ / ₁₆ "	2' 7 ¹ / ₁₆ "	2' 7 ³ / ₁₆ "
Hawa Divido 100 H/HM/GR	1' 6 ²⁹ / ₃₂ "	1' 9 ¹ / ₁₆ "	1' 11 ¹ / ₄ "	2' 4 ³ / ₄ "	2' 6 ²⁹ / ₃₂ "	2' 9 ³ / ₃₂ "
Hawa Divido 100 GRM	1' 8 ⁵ / ₃₂ "	1' 10 ¹¹ / ₃₂ "	1' 0 ² / ₂ "	2' 6"	2' 8 ⁵ / ₃₂ "	2' 10 ¹¹ / ₃₂ "

*	Z =					
	1		2		2	
	0	1	2	0	1	2
Hawa Porta 60/100 H/H/C	480	535	590	730	785	840
Hawa Porta 60/100 HM/HMD/HMT	480	535	590	730	785	840
Hawa Porta 100 G/GU/GM/GMT	480	535	590	730	785	840
Hawa Porta 100 GF	480			730		
Hawa Porta 100 GW/GWF	512	542	590	762	792	840
Hawa Porta 100 GMD	488	539	590	738	789	840
Hawa Divido 100 H/HM/GR	480	535	590	730	785	840
Hawa Divido 100 GRM	512	567	622	762	817	872

Beidseitig gedämpfte Ausführungen ohne stirnseitigen Zugang erfordern zwei Montageöffnungen.
 Versions with soft closing mechanism at both sides without access from the leading edge require two assembly openings.
 Les versions avec amortissement bilatéral sans accès frontal exigent deux ouvertures de montage.

Accessories

- Lock solutions from page 511
- General accessories from page 518
- Glass recommendations from page 536

Planning/execution

Further information about the product can be found on www.hawa.com.